

GOVI ARKTIK 2000US
 -THERMOMETER
 -LIGHT SWITCH

4" WALLS & ROOF
 HEAVY DUTY FLOOR
 STRIP CURTAINS
 LED LIGHTING
 7 BLADE CONNECTOR
 2⁵/₁₆" COUPLER

GVWR: 7,000 LBS.
 TRAILER: 2,660 LBS.
 CAPACITY: 4,340 LBS.

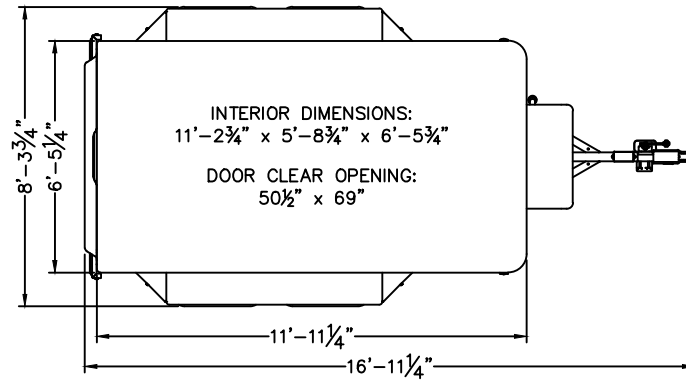

ROOM TEMP.:
 0°F to 50°F
 INTERIOR VOLUME:
 416 cu. ft.
 HORSEPOWER:
 3/4 hp.
 REFRIGERANT:
 R-452A
 ELEC. SUPPLY
 115V
 PHASE:
 Single
 CYCLE:
 60 hz.
 AMPERAGE:
 15.0 MCA
 R-VALUE:
 R-28

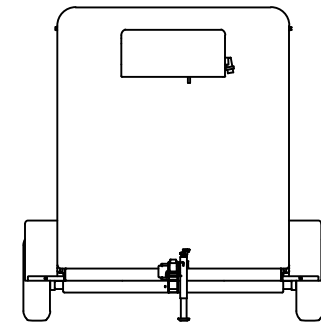
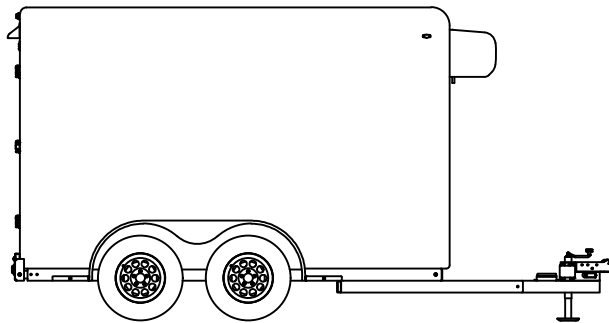
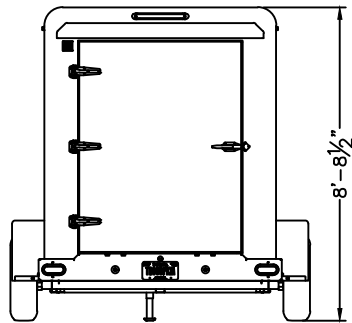

Polar King Mobile

DRAWN BY: MJR	MODEL NO.: PKM612	SCALE: 3/16" = 1'	DATE: 10/28/20
------------------	----------------------	----------------------	-------------------

DRAWING NAME: Polar King Mobile 2D

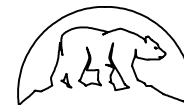

POLAR KING
 INTERNATIONAL, INC.